



Copyright © 2022 Anthony, Inc. A Dover Company All rights reserved. Information in this document is subject to change without notice. No part of this document may be reproduced or transmitted in any form or by any means, electronic or mechanical, for any purpose, without permission of Anthony, Inc. All product and company names are trademarks™ or registered® trademarks of their respective holders. Use of them does not imply any affiliation with or endorsement by them unless otherwise specified.

Anthony products identified in this manual are designed and certified to meet  or  for safety.

Each customer is responsible for final site approval. All products and company names mentioned in this document are trademarks™ or registered® trademarks of their respective holders. Use of them does not imply any affiliation with or endorsement for them or by respective holders.

Anthony Locations

Anthony is a manufacturer and solutions provider of glass doors, lighting systems and display equipment for use in commercial refrigeration systems. For more information on Anthony, please visit www.anthonynatl.com.

Sylmar, CA

Corporate Offices
12391 Montero Avenue
Sylmar, CA 91342
Phone : 818.365.9451
Toll Free US: 800.772.0900
Canada : 800.336.8825
Fax : 818.365.2441

Madison, GA

1101 Sovis Rd
Madison, GA 30650
Phone: 706.342.9300
Fax: 706.342.9303

Conyers, GA

709 Sigman Road NE
Conyers, GA 30013
Phone: 678.607.3800
Fax: 678.607.3700

For Replacement parts go to www.anthonystore.com

For our latest instructional and informative videos visit our  channel

For the latest news and upcoming product releases follow us on these social media platforms:



TWITTER



YOUTUBE



LINKEDIN

Table of Contents

| | |
|---|-----------|
| INTRODUCTION..... | 4 |
| PROPER USE OF DOVER PRODUCTS | 4 |
| SECTION 1 - SAFETY..... | 5 |
| SAFETY MESSAGES | 5 |
| SIGNAL WORDS | 5 |
| SAFETY COLORS | 5 |
| SAFETY ALERTS SYMBOLS..... | 6 |
| USER SAFETY..... | 7 |
| SECTION 2 – EQUIPMENT, TOOLS, & MATERIALS LIST | 8 |
| SECTION 3 - STORE CONDITION REQUIREMENTS..... | 9 |
| Table 3.1 Operating conditions..... | 9 |
| OPERATING REQUIREMENTS AND RECOMMENDATIONS FOR OPTIMAL PERFORMANCE..... | 9 |
| SECTION 4 - KODIAK FRAME INSTALLATION | 11 |
| NET OPENING | 11 |
| FRAME INSTALLATION | 11 |
| Figure 4.1: Frame Alignment, Squareness and Plumb | 11 |
| SHIMMING THE FRAME | 13 |
| SEALING THE FRAME | 14 |
| Figure 4.3: Frame Shimming and Sealing Details..... | 14 |
| FRAME HANDLING DURING INSTALLATION..... | 14 |
| Other Frame Installation Recommendations & Suggestions..... | 14 |
| FRAME FLOOR ANCHORING..... | 15 |
| Figure 4.2: Hinge Plate Removal | 15 |
| Figure 4.3: Floor Anchoring | 15 |
| Figure 4.4: Re-Installing Hinge Plate | 16 |
| SECTION 5 - KODIAK DOOR INSTALLATION..... | 17 |
| DOOR INSTALLATION | 17 |
| Figure 5.1: Aligning Door Hinge Cavity to Bottom Hinge Pin | 17 |
| Figure 5.2: Top door hinge alignment and installation..... | 17 |
| DOOR ALIGNMENT AND ADJUSTMENTS | 18 |
| Figure 5.3: Squareness adjustment points | 18 |
| DOOR CLOSER INSTALLATION | 18 |
| Figure 5.4: Installing Door Closer Arm to Frame..... | 18 |
| Figure 5.5: Installing Door Closer Arm to Door Bracket..... | 19 |
| POWER WHIP INSTALLATION | 19 |
| Figure 5.7: Installing Power whip..... | 19 |
| General Kodiak Door Closer Information | 20 |
| DOOR CLOSER ORIENTATION..... | 20 |
| Figure 5.8: Door Orientation..... | 20 |
| DOOR CLOSING CONTROL..... | 20 |
| Figure 5.9: Door Closing Control..... | 20 |
| DOOR OPENING CONTROL | 21 |
| Figure 5.10: Door Opening Control..... | 21 |
| DOOR REMOVAL | 21 |
| Figure 5.11: Door Removal | 21 |
| WIRING DIAGRAMS | 22 |
| Figure 5.12: Single Door, Frame Wiring Diagram | 22 |
| Figure 5.13: Double Door, Frame Wiring Diagram | 23 |
| Figure 5.14: Door Wiring Diagram | 24 |

SECTION 6 -ROUTINE PREVENTATIVE MAINTENANCE 25
 Table 6.1 Recommendations25
 GLASS CLEANING INSTRUCTIONS25
 Standard Glass Cleaning.....25
 PREVENTATIVE INSPECTION AND MAINTENANCE27
 GASKET REPLACEMENT GUIDELINES.....27
 Preliminary Considerations for Servicing Gaskets27
 Tools Required27
 Recommendations and Suggestions.....27
SECTION 7 - TROUBLE SHOOTING..... 28
 Table 7.1: Installation Troubleshooting28
SECTION 8 - FRAME AUTO-LOCK REPLACEMENT INSTRUCTIONS 29
 Door Removal29
 Frame Removal30
 Electrical Auto-Lock wiring diagram0
REVISION HISTORY 0

Introduction

This manual provides information required to perform installation of the Kodiak Super Duty Pass-Thru Door. This manual is intended as a written guide for personnel who are properly trained and qualified to safely use a variety of different equipment and tools required during the installation, commissioning, repairs, and performing maintenance of the Kodiak Super Duty Pass-Thru Door.

All personnel/contractors assigned to install Kodiak Super Duty Pass-Thru Door must read this manual in its entirety as one of the steps in being certified to install and work on Anthony doors. Failure to read and thoroughly understand the material contained in this manual may ultimately result in damage to the equipment, injury to personnel, and could void the warranty.

The components and systems described in this manual may be operated only by personnel qualified for the specific task in accordance with the relevant documentation the warning notices and safety instructions. Qualified personnel are those who, based on their training and experience can identify risks and avoiding potential hazards when working with these types of components and systems.

Proper use of Dover Products

Dover's products may only be used for the applications described in the catalog and in the relevant technical documentation. If products and components from other manufacturers are used, these must be recommended or approved by Dover. Proper transport, storage, installation, assembly, commissioning, operation, and maintenance are required to ensure that the products operate safely and without any problems. The permissible ambient conditions must be complied with.

Dover has reviewed the contents of this publication to ensure consistency with the hardware and/or software described. Since variance cannot be precluded entirely, we cannot guarantee full consistency. However, the information in this publication is reviewed regularly and any necessary corrections will be included in subsequent editions. Specifications and information are subject to change without notice.

Section 1 - Safety

Safety Messages

This manual includes general, task-specific and important Safety Messages. Each Safety Message includes several elements, Signal Words, Safety Alert Symbols, Safety Colors, and Safety Message. The following is an example of a safety message with all elements included.

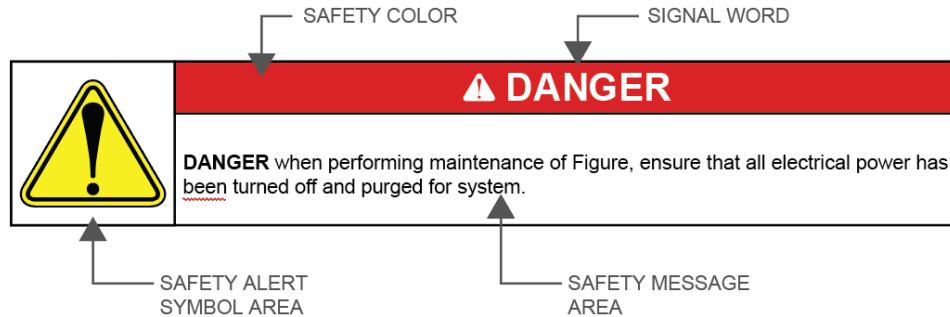

These Safety Messages are defined by level of severity and are found throughout the manual indicating measures that must be taken while performing the specific task at hand.

Signal Words

- **DANGER:** Indicates a hazard which, if not avoided, **WILL** result in death or serious injury.
- **WARNING:** Indicates a hazard which, if not avoided, **COULD** result in death or serious injury.
- **CAUTION:** Indicates a hazard which, if not avoided, **WILL** result in minor or moderate injury.
- **NOTICE:** Indicates a hazard or practice that, if not avoided, **CAN** result in equipment or property damage.
- **SAFETY INSTRUCTIONS:** Indicates safety-related instructions, procedures or the locations of safety equipment.

Safety Colors

| COLOR | SAMPLE | |
|--------|--------|--|
| RED | | DANGER |
| ORANGE | | WARNING |
| YELLOW | | CAUTION |
| BLUE | | NOTICE |
| GREEN | | SAFETY INSTRUCTIONS |
| GREY | | ASSEMBLY, MAINTENANCE OR SERVICE ALERT |

Safety Alerts Symbols

Your safety and the safety of others is very important. The following Safety Alert Symbols will be used in conjunction with the Safety Messages to warn of potential risks when installing or maintaining your Kodiak Door. These Safety Alert Symbols communicate hazardous information quickly and reinforce the Safety Message without the use of words and across language barriers. These safety messages alert you to potential hazards that could hurt you or others or render damage to Dover products. Each safety message is associated with a safety alert symbol. These symbols are found in the throughout the manual. The definition of these symbols is described below:

| | | | |
|---|--|---|---|
|  | <i>Protective Eyewear– Potential risk of eye injuries, protective eyewear required when performing this and any other associated tasks.</i> |  | <i>Stop – Before you begin: Installation of this assembly requires a person familiar with the construction and operation of electrical systems and the Hazards involved. Read instructions completely and carefully.</i> |
|  | <i>Protective Footwear– Potential risk of injury to your feet, protective footwear is required when performing this and any other associated tasks.</i> |  | <i>Risk of Electrical Shock– Potential risk of Electrical Shock; pay close attention to instructions when performing this and any other associated tasks.</i> |
|  | <i>Protective Gloves– Potential risk of injury to your hands, protective gloves required when performing this and any other associated tasks.</i> |  | <i>Commercial Refrigeration – This symbol indicates for use inside a commercial refrigeration case with packaged foods only.</i> |
|  | <i>Hearing Protection– Potential risk of injury to your ears, protective ear coverings required when performing this and any other associated tasks.</i> |  | <i>Warning – To reduce the risk of fire, electrical shock or injury observe the following:</i> <ul style="list-style-type: none"> • Use this unit in the manner intended by the manufacturer. • Turn power off before removing existing lighting system and follow appropriate lock out/tag out safety procedures |
|  | <i>Safety Vest– Wearing a high visibility vest is required when performing this and any other associated tasks.</i> |  | <i>Heavy object symbol– Single person lift could cause muscle strain or back injury. Get help when moving or lifting. Use other proper lifting aids, seek assistance, and always use proper lifting techniques when moving.</i> |
|  | <i>Long Pants– Wearing a long pants are required when performing this and any other associated tasks.</i> |  | <i>Note – This will contain information that is helpful for a procedure, condition, or operation. Read instructions completely and carefully.</i> |
|  | <i>Read Instructions symbol– Read and understand manual and all other safety instructions before proceeding.</i> |  | <i>Handle with care symbol– Indicates that specific items require care when handling.</i> |
| | |  | <i>Pinch Hands symbol – Potential risk of hands sustaining injury in pinching points.</i> |

User Safety

General safety rules

These safety rules apply:

Always keep the work area clean.
Pay attention to the risks presented by obstacles or other people in the work area.
Avoid all electrical dangers.
Pay attention to the risks of electric shock or arc flash hazards.
Always bear in mind the risk of pinching, electrical accidents, and broken glass.
Always seek assistance from another person when handling a Kodiak Door.

Safety equipment – Personal Protective Equipment

Use safety equipment according to the company, local, and state regulations. Use this safety equipment within the work area when performing any type of work on Kodiak Doors:

Safety goggles
Protective shoes
Protective gloves
Long Pants
Hearing protection
First-aid kit
Other Safety devices

Electrical Connections

Electrical connections must be made by certified electricians in compliance with all international, national, state, and local regulations.

Precautions before work

Observe these safety precautions before you work on Kodiak Doors installation or service:

Provide a suitable barrier around the work area; For example, a caution sign/tape, as allowed by site manager.
Ensure all safety guards are in place and secure.
Recognize the site emergency exits, eye wash stations, emergency showers and toilets.
Ensure clear path of retreat.
Ensure the door will not fall over and/or injure people and/or damage property.
Ensure lifting equipment is in good condition.
When using a lifting device, safety device, or other equipment seek assistance when needed.
Ensure the door is thoroughly clean.
Ensure quick access to a first-aid kit.
Disconnect and lock out power before servicing.

| WARNING – California Proposition 65 | |
|---|--|
|  | <p>WARNING –This product can expose you to chemicals known to the State of California to cause cancer, birth defects or other reproductive harm. For more information go to www.P65Warnings.ca.gov.</p> |

Section 2 – Equipment, Tools, & Materials List

The following is a list of all the different equipment, tools, materials, and other things you will need when installing the Kodiak Doors.

Anthony Parts Required:

Door Closer Kit

Tools:

#2 Philips screwdriver
Flat-head screwdriver
Needle-nose pliers
Wire stripper/cutter
Rubber/plastic mallet
5/32" (4mm) Allen Wrench
Voltage tester
Utility knife

Frame Installation:

Shims
Silicone/Butyl
RTV-108 NSF Approved Silicone Caulk
Caulking gun
4' - 6' level
Tape measure

Other Materials:

Dielectric grease
Foam glass cleaner (Ammonia free)
Micro thermo cloths
Black permanent marker
Towels / rags
Broom
Corrosion Resistant Flat Head Screw: 1/4" Diameter, 1 1/4" minimum length

Section 3 - Store Condition Requirements

The installation of the Kodiak Door in various applications require specific store conditions to achieve optimal performance. Please note that ambient conditions in your store may vary throughout the day. Dover/ Anthony Doors are built to ANSI/ASHRAE Standard 72-2014 Test Standard.

**Cooler refers to either a walk-in cooler or NT refrigerated display case.*

Table 3.1 Operating conditions

| Required Ambient Conditions |
|---------------------------------|
| 75°F, 55%RH AMBIENT/35°F |

| WARNING | |
|---|--|
|  | <p><i>Stop – Cooler and store operating conditions that exceed the required limits may cause condensation and result in sweating of doors. Facility operators should monitor the cooler and store operating conditions on a regular basis to ensure the required conditions are met.</i></p> |

Operating Requirements and Recommendations for Optimal Performance

- Recommend HVAC vents do not blow directly on doors.
- Cooler temperature settings must not operate below recommended temperatures: Refer Table 3.1 Operating conditions above.
- Evaporators must be equipped with defrost termination control to end the termination early if the coil is cleared. Recommend scheduling defrost during low traffic periods. Adjust the duration of evaporator defrosts according to the manufacturer’s recommendations.
- Cooler must be regularly inspected for air leaks. Identified air leaks must be sealed. Visually inspect box penetrations and adjoining surfaces: use of a flashlight is helpful. A smoke stick can be used to validate an infiltration while the cooler is operating.
- Avoid direct evaporator air impingement on the cooler door.
- It is strongly recommended that air deflectors be installed in every evaporator inside the walk-in cooler. Refer to Figures 3.1 and 3.2.

Figure 3.1: Product Stocking – Shelves required to be fully stocked

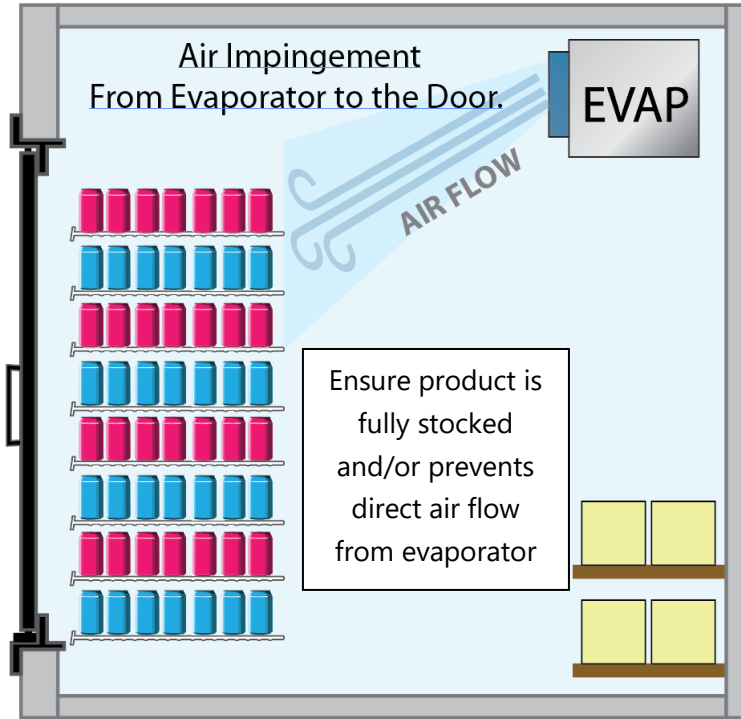
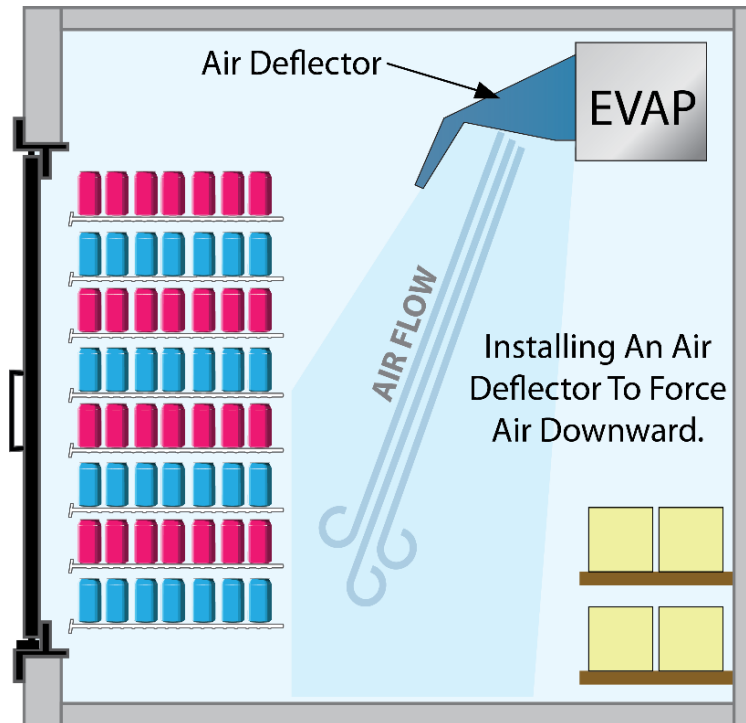

Figure 3.2: Evaporator Air Deflector - Contact evaporator manufacturer for recommended air deflector.





Section 4 - Kodiak Frame Installation

The first step to installing your new Kodiak door requires the frame installation. In this section the steps required to install frame will be covered, please read and fully understand instructions completely before installing frames.

Net Opening

Read instructions in this Section completely before installing the frame. Prior to installing the frame, confirm that the size of the net opening accommodates the finish frame, net opening should be 1/8" larger than the frame size, this is 1/16" all around equally gap around the frame. If the tolerances exceed 3/8", the net opening will have to be enlarged.

- Header and Jack studs must be completely square, level and plumb. Also make sure these are free from debris that may interfere with frame sitting flush to floor.
- If the Gap between frame and net opening is greater than 1/16", shim the gap for proper fit.

| PROTECTIVE GEAR NOTICE | |
|---|--|
|  | <i>Protective Gloves – Potential risk of injury to your hands, protective gloves required when performing this and any other associated tasks.</i> |
|  | <i>Footwear Protective – Potential risk of injury to your feet, wearing protective footwear is required when performing this and any other associated tasks.</i> |

Frame Installation

The following instructions will ensure proper frame installation:

1. When installing frame, DO NOT install Frame directly on Sheetrock, frame is designed to be installed to Cooler/Refrigeration Cases Boxes only.
2. Make sure to DO NOT force the frame if the fit is too tight, doing so may cause you to break the Sealing Frame Flap or tweak the Frame.
3. Ensure that the Sealing Frame Flap is fully engaged the to, Sill, Header, and Jack Studs creating a seal without any gaps (see Figure 4.3).
4. Insert a mounting screw into a mounting hole in each corner of the frame and tighten each screw until it is approximately a quarter inch from flush.
5. Check the frame is aligned properly or square.
6. Use a measuring tape to measure diagonally one corner to the opposite and note the distance.
7. Measure the distance between the remaining two corners.
8. Both measurements should be the same, or within a 1/16" difference.

Figure 4.1: Frame Alignment, Squareness and Plumb

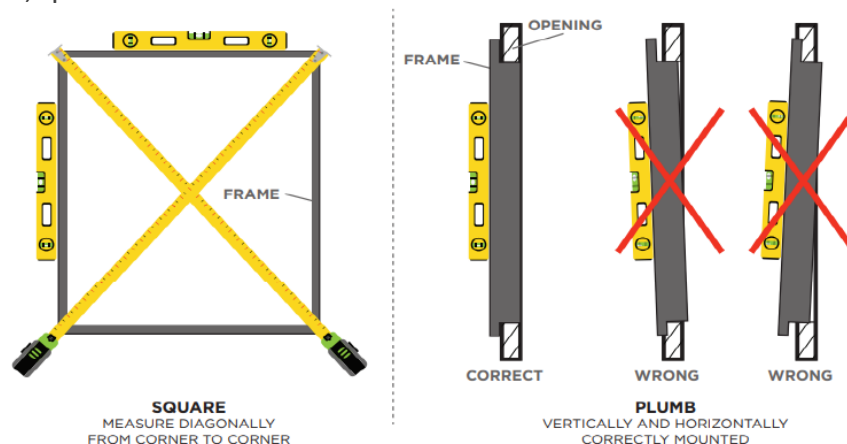

9. Confirm the frame and frame flanges are vertically and horizontally aligned (plumb) to the wall surface around the net opening.
10. Place a level on the top flange of the header frame to check if it is horizontally aligned.
11. If the top of the header frame sags or bows, correct as necessary.
12. When the frame is completely aligned, tighten all mounting screws securely until each is flush to the frame surface. DO NOT over-tighten the screws, as this can cause the frame to become out of square.

| WARNING | |
|---|---|
|  | <p><i>Warning: DO NOT over tighten screws on to frame, as this may cause bowing, sagging or the frame to become out of square. This will cause installation issues with Smart Doors proper function. Adjusted the frame as needed to ensure it is square and free of bowing and sags.</i></p> |

13. Check entire frame to ensure installation is correct. If needed see refer to “Shimming Frame” section for instructions on how to use shims to align frame properly.

| NOTICE | |
|---|---|
|  | <p><i>If the floor is not level, a shim may be required under the bracket to keep the bracket level with the frame.</i></p> |

Shimming the Frame

Shimming is only to be used when necessary and will primarily be done at the header (top) of frame and opening. If the gap between the frame and net opening is greater than 1/16", proceed to shim the gap for a proper fit. Refer to Figure 4.3, below for detailed view of Shim location. If everything is aligned, squared, plumb and gaps do not exceed 1/16" skip the shimming process and proceed to sealing the Frame refer to "Sealing the Frame" below for instructions.

The following instructions will ensure properly shim frame when necessary:

1. Acquire sturdy, penetrable material, such as plywood. The thickness of the material should be wedge shaped and slightly less than the gap to be filled, remember if gap is larger than 1/8" opening must be reduced properly accommodate the frame.
2. When using shims, they must be installed from left to right or top to bottom, **PARALLEL** to frame width or height.
3. Measure the length of the gap (height or width of frame) and cut the shim material to 1/16 of an inch less than the measured length.
4. Install the shim using the same type of mounting hardware that will be used to install the frame. Be certain that the shim installation hardware will not interfere with the frame installation hardware.
5. If necessary, cut a second shim to the same length and install it in the opposite side of the net opening.
6. If the adjacent sides of the net opening need to be shimmed, repeat the previous steps, matching the shim length to the frame sides of the net opening (less 1/16 of an inch).
7. Shims must **NOT** be used in a perpendicular manner.
8. Excess shim material **MUST** be removed to ensure proper sealing to frame.

Sealing the Frame

The electrical connection at the Junction Box where the wires enter the frame, and where the wires enter the raceway in the frame must be sealed with NSF Approved Food Grade Silicone Sealant (RTV-108) at the time of installation. Ensure to seal the gap between the frame and the surrounding wall, inside case, or cooler. Not following these procedures can void Dover and Anthony's Service & Warranty on condensation and ice build-up issues.

The following instructions will ensure proper sealing of the frame:

1. Always ensure that you can locate the Foam insert that lines the entire flange around the Frame; DO NOT remove this foam, it is critical to ensure proper insulation.
2. Ensure that the bubble seal gasket is fully engaged the to, Sill, Header, and Jack Studs creating a seal without any gaps.
3. Ensure that any excess shimming material is removed as instructed in "Shimming Frame" section.
4. Seal the back (cold side) of the frame with a bead of food grade silicone sealant (RTV – 108) no larger than 3/8" to prevent any air leaks.
5. Follow manufacturer's curing instructions for the Silicone Sealant (RTV-108) to ensure proper use.
6. Once Silicone Sealant is cured double check for any remaining gaps that require more sealant.

Figure 4.3: Frame Shimming and Sealing Details

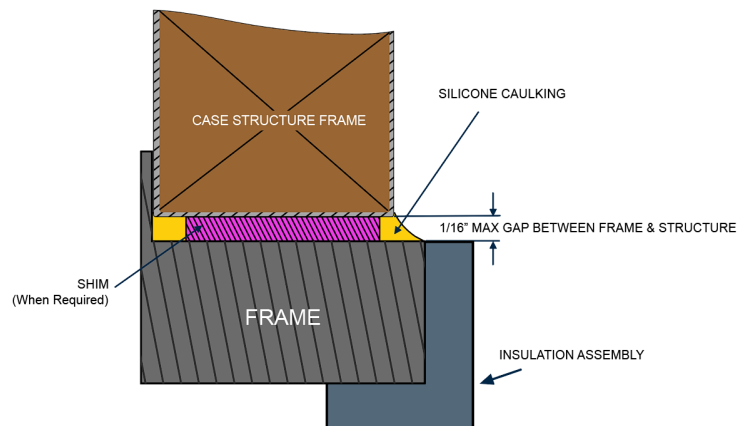

| WARNING | |
|---|--|
|  | <p>Warning: Use only food grade silicone sealant (add caulking for larger gaps) to seal the gap between the frame and the surrounding wall, inside case, cooler or freezer. Not following these procedures can void Anthony's Service & Warranty on condensation and ice build-up issues.</p> |

Frame Handling during Installation

If needed we recommend using either Gripe, Bar, F, Sliding, or Speed Clamp to align and squeeze Frame into net opening. When using clamps ensure to gradually squeeze slowly to prevent the frame from bending or cracking.

Other Frame Installation Recommendations & Suggestions

1. Complete replacement of wire assemblies is recommended whenever required.
2. Splice wires only if necessary, using proper materials such as electrical tape, wire nuts, flux core solder and heat shrink.
3. Apply liquid soap to rail plastic covers and gaskets upon installation, to facilitate insertion into mounting grooves.
4. Keep doors and frames clean for product efficiency. This can also help reduce energy consumption and potential health hazards.
5. Whenever binding gasket or plastic parts only use food grade silicone.
6. Always use the correct tool for the job to be performed. This ensures proper installation and minimizes safety risks.
7. If there is any doubt about the work to be performed, consult with a certified technician or Dover/Anthony representative.
8. Preventative maintenance is recommended to ensure product longevity.
9. Ensure to have correct replacement screw size, quantity and type if replacing with non-Dover or non-Anthony hardware.
10. Do not over tighten screws when installing.

Frame Floor Anchoring

Follow the next steps to securely anchor the Bottom Hinge Bracket to the Floor.

1. Before you can anchor the Bottom Hinge Bracket to floor you must remove the Hinge Plate that is secured onto the bottom hinge bracket with two (2) screw. Using a Flat head screwdriver remove screws. Refer to Figure 4.2 A.
2. Once Hinge Plate is removed, the countersunk hole located in the center of the bottom hinge bracket is exposed and you will use this to anchor to the floor. Refer to Figure 4.2 B.

Figure 4.2: Hinge Plate Removal

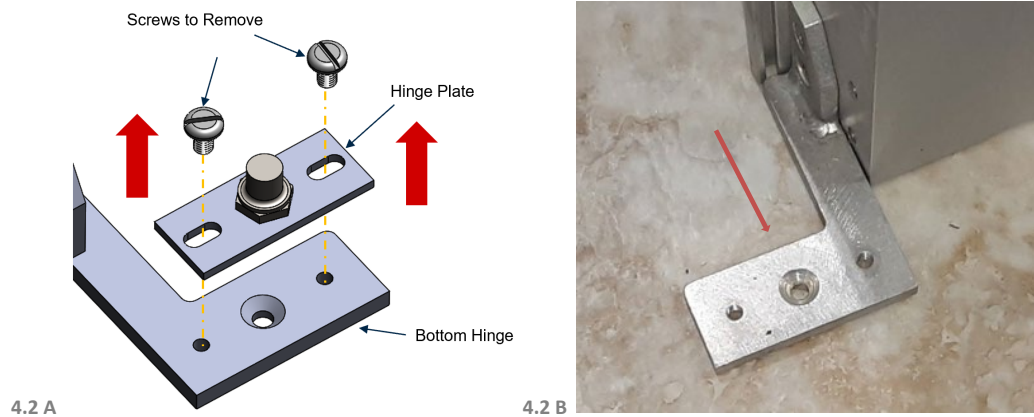

3. You will need to use Flat head screw (which is not provided with this product) - 1/4" Diameter Screw, 1 1/4 "minimum length, Corrosion resistant and Flat head (countersunk). Refer to Figure 4.3A to Figure 4.3 B for example of anchoring screw to use.

Figure 4.3: Floor Anchoring



| NOTICE | |
|---|--|
|  | <p><i>We commended using the appropriate anchoring screw, typical screws used to secure the bottom hinge bracket to concrete floor are the following:</i></p> <ol style="list-style-type: none"> 1. <i>RED Head® Threshold Concrete Anchor Screws</i> 2. <i>Tapcon® Concrete Anchor Screws</i> |

- Once bottom hinge bracket is secured and anchored to floor the hinge plate must be re-installed onto the bottom hinge plate. Refer to Figure 4.4.
- Re-use the two (2) screws shown in Figure 4.4 to secure the hinge plate.

Figure 4.4: Re-Installing Hinge Plate

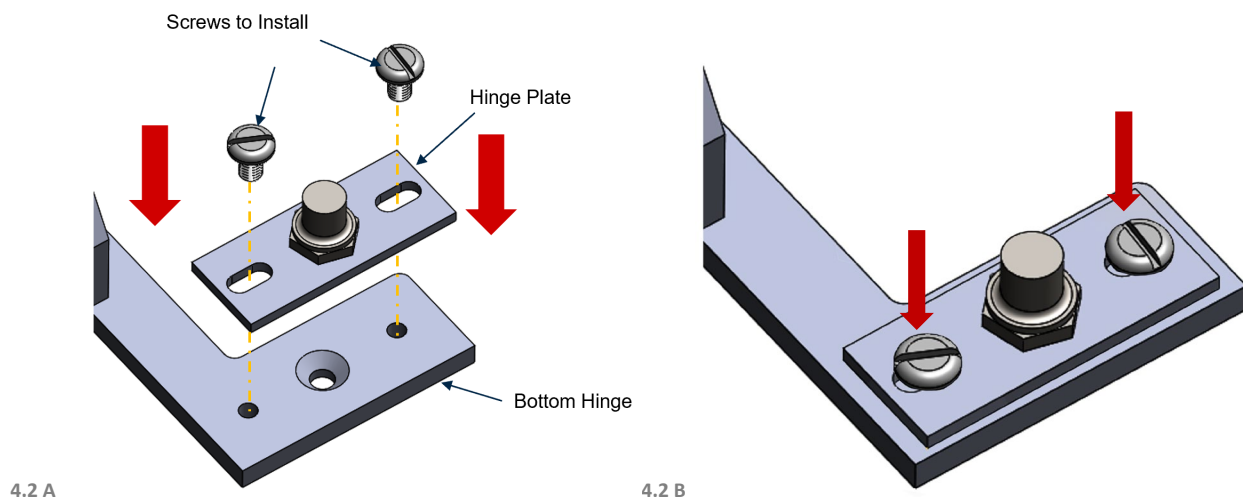

- Once all these steps are complete proceed to Section 5 – Kodiak Door Installation.

Section 5 - Kodiak Door Installation

Door Installation

In this section the steps required to install Kodiak Door will be covered, please read, and fully understand instructions completely before installing door(s).

1. Handling each door carefully, install them into the frame, one at a time.
2. Begin by lifting door and aligning the bottom door hinge cavity with the bottom hinge pin, as shown in Figure 5.1.
3. Carefully place door onto the bottom hinge pin ensuring it is captured within the door hinge cavity.

Figure 5.1: Aligning Door Hinge Cavity to Bottom Hinge Pin

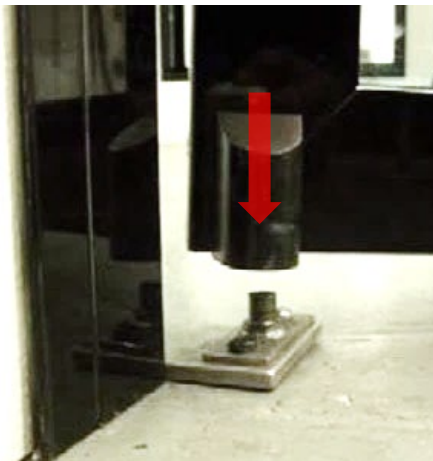

4. Once bottom door hinge is secure, tilt the top of the door toward the frame, push down on the spring-loaded hinge pin located on top of the door and align with and release pin into the top upper frame hinge point cavity making sure that the spring-loaded pin engages into the top upper frame rail hinge point cavity.

Figure 5.2: Top door hinge alignment and installation





Door Alignment and Adjustments

The following steps will guide you on how to adjust do hinges to ensure door closes correctly.

1. Adjust the door swing and door squareness by adjusting the top and bottom hinge points (right to left). There are 2 set screws per hinge point that can be loosened, adjusted, and then tightened. Refer to Figure 5.3

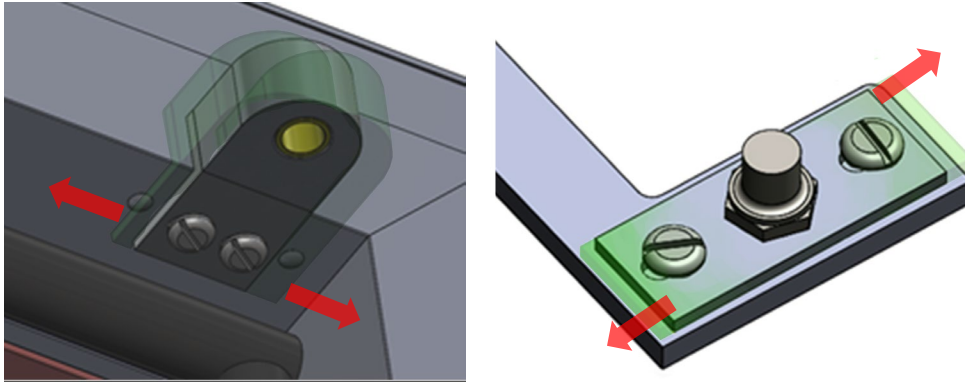
Figure 5.3: Squareness adjustment points



| CAUTION | |
|---|--|
|  | <p><i>CAUTION –Improper adjustment may result in personal injury or property damage. Please follow all instructions carefully.</i></p> |

Door Closer Installation

2. Align door closer arm with pivot point located on the inner rail at the top of the frame and insert screw and secure by tightening the as shown in Figure 5.4.

Figure 5.4: Installing Door Closer Arm to Frame



3. Open Door at 45 degrees.

4. Align door closer arm with bracket located on the inner door rail at the top of the door and insert the threaded Pin through top of the middle hole of the bracket and ensure the pin captures door closer arm. Once pin is in place insert the screw and secure in place Refer to Figure 5.5.

Figure 5.5: Installing Door Closer Arm to Door Bracket



| NOTICE | |
|---|--|
|  | <i>See the Door Closer instructions for proper adjustment.</i> |

5. Install the power whip by plugging it into the hinge side upper frame mounted electrical box and use a Phillips Head screwdriver to secure it properly.

Power Whip Installation

Figure 5.7: Installing Power whip



General Kodiak Door Closer Information

The Kodiak Door Closer has a cast aluminum body and a duro bronze finish. The adjustable power size requires less than 5 pounds of force to open. Standard features include sweep and latching speeds and adjustable backcheck.

Door Closer Orientation

The Kodiak Door Closer is oriented for both left-hand and right-hand doors.

Figure 5.8: Door Orientation

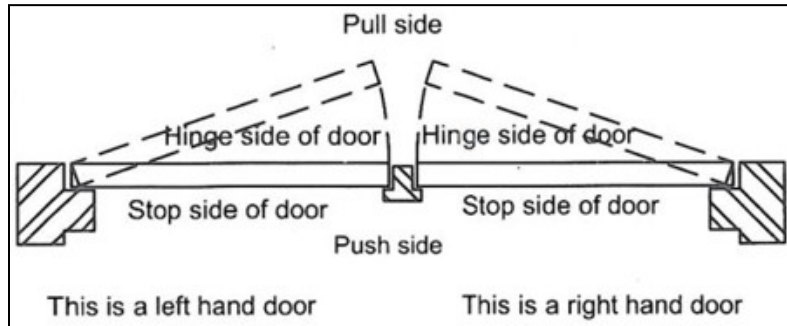

Door Closing Control

Adjust closing time to between 4 and 6 seconds from 90 degrees. Use of the door by handicapped elderly or small children may require a longer closing time.

Figure 5.9: Door Closing Control

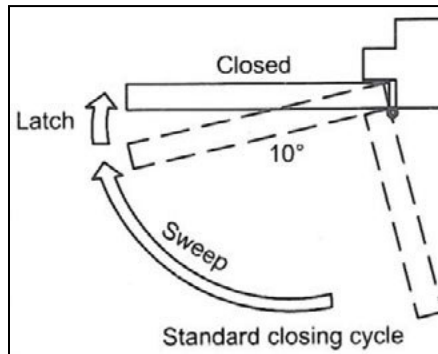



| CAUTION | |
|---|---|
|  | <p><i>CAUTION – Do not back valves out of closer or a leak will result.</i></p> |

Door Opening Control

Backcheck (BC) valve controls the hydraulic resistance to the door opening in the backcheck range. NEVER close this valve completely. It is NOT to provide a positive stop.

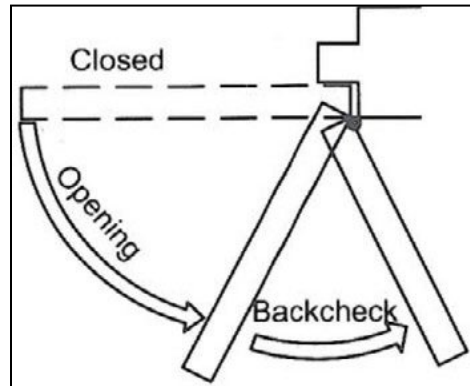
Figure 5.10: Door Opening Control



| CAUTION | |
|---|--|
|  | <i>CAUTION – Do not back valves out of closer or a leak will result.</i> |

Door Removal

The following instructions will guide you on how to properly remove the door when needed. Refer to Figure 5.11.

1. Remove the cap from top hinge with screwdriver.
2. Insert and push down the spring-loaded pin from the top to disengage the door from frame.

Figure 5.11: Door Removal



Wiring Diagrams

Figure 5.12: Single Door, Frame Wiring Diagram

SINGLE DOOR

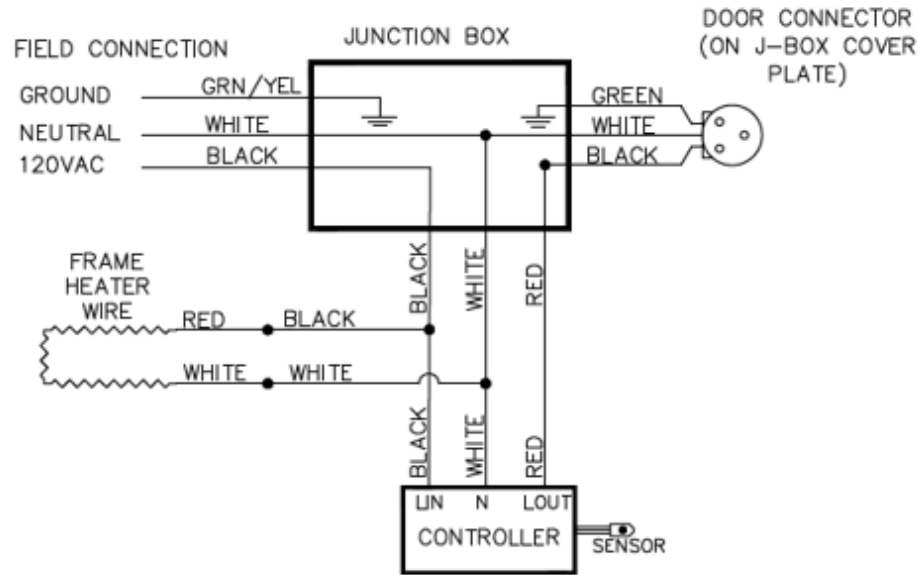

NOTES:

1. UNITS WITHOUT HEAT WILL NOT HAVE ANY WIRING.
2. 120V ONLY. OTHER VOLTAGES NOT AVAILABLE.

SYMBOLS:

- ⊕ WIRES CONNECTED
- ⊖ WIRES NOT CONNECTED
- ⊥ WIRE CONNECTED TO METAL (GROUND)

Figure 5.13: Double Door, Frame Wiring Diagram

DOUBLE DOOR

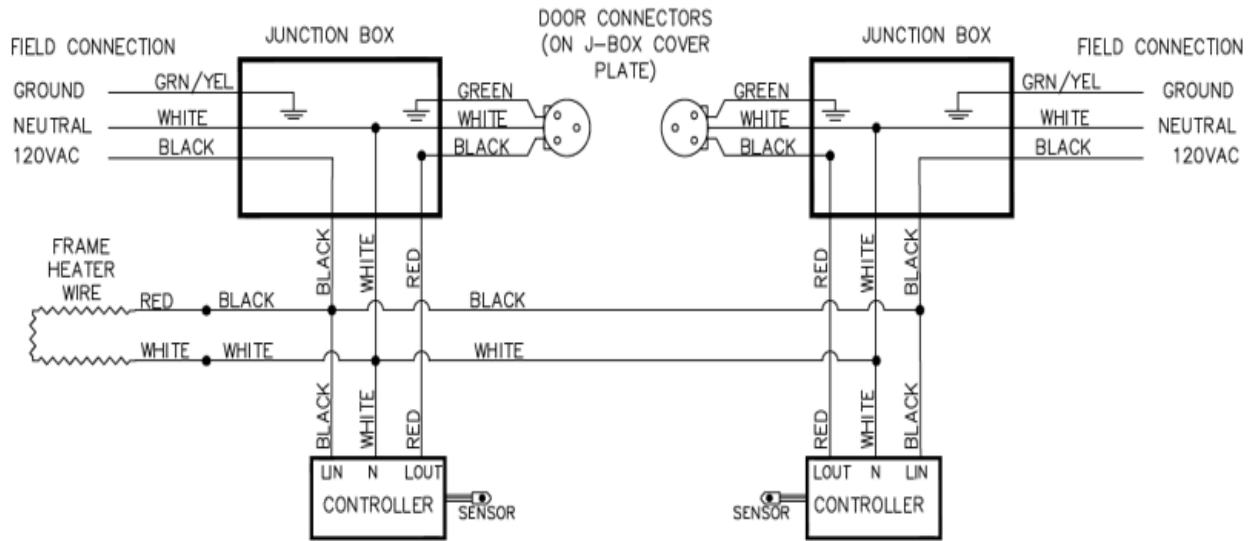

NOTES:

1. UNITS WITHOUT HEAT WILL NOT HAVE ANY WIRING.
2. 120V ONLY. OTHER VOLTAGES NOT AVAILABLE.

SYMBOLS:

- ⊕ WIRES CONNECTED
- ⊖ WIRES NOT CONNECTED
- ⊥ WIRE CONNECTED TO METAL (GROUND)

Figure 5.14: Door Wiring Diagram

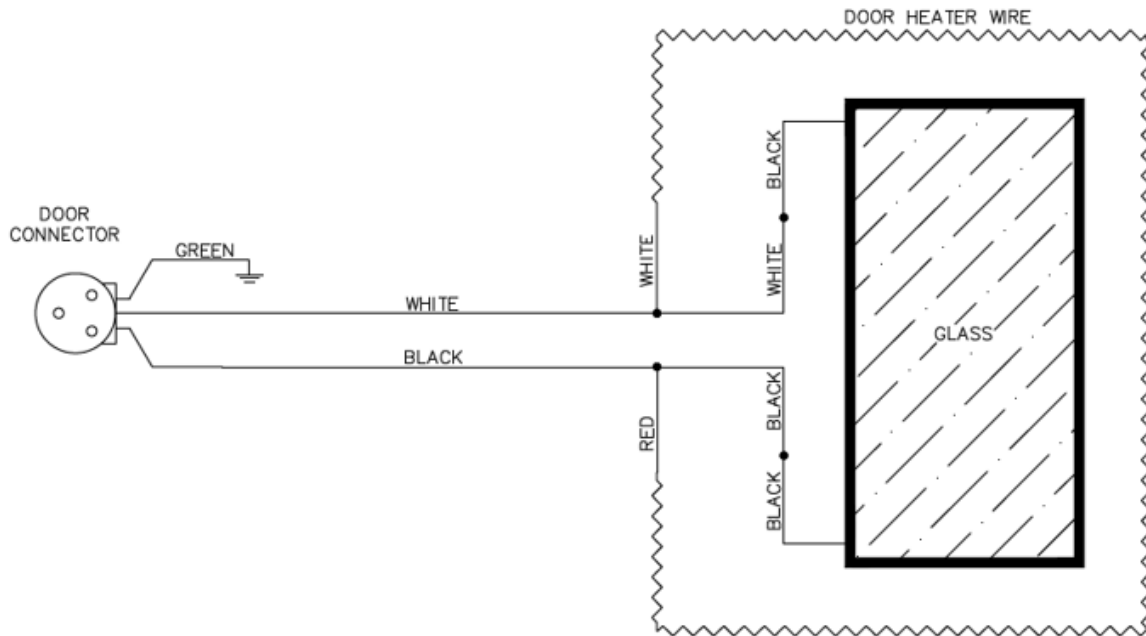

NOTES:

1. 120V ONLY. OTHER VOLTAGES NOT AVAILABLE.
2. NON-HEATED DOORS WILL NOT HAVE ANY WIRING.
3. ALL COMPONENTS SHOWN: ACTUAL BUILD DETERMINED BY OPTIONS ON WORK ORDER.
4. RED WIRE MAY BE SUBSTITUTED FOR BLACK.

SYMBOLS:

- ⊕ WIRES CONNECTED
- ⊖ WIRES NOT CONNECTED
- ⊔ WIRE CONNECTED TO METAL (GROUND)

Section 6 -Routine Preventative Maintenance

This section provides the information needed to safely perform regular preventive maintenance. Regular preventative inspections will maximize the longevity of the product. Simple tasks as cleaning surfaces can go a long way in ensuring optimal performance. Depending on maintenance being performed you may need to shut down door or kill all power to the doors.

As use frequency of doors will vary from location to location, the frequency in routine for preventative maintenance will vary for everyone depending on amount of traffic. Here is a quick standard recommendation:

Table 6.1 Recommendations

| Action | Description |
|---|------------------------------------|
| Preventative Inspection | Once each quarter (every 3 months) |
| Cleaning | Once a month (every 30 days) |
| <i>Note: These are just recommendations based on historical data of other Anthony door products and can vary depending on location, store conditions, store traffic, and other unknown variables.</i> | |

Glass Cleaning Instructions

| NOTICE | |
|---|---|
|  | <p><i>The following section contains important information about cleaning Standard glass. Please read and follow these instructions to prevent damage to the glass.</i></p> |

Standard Glass Cleaning

Standard Anthony tempered glass is susceptible to scratching if abrasive materials are used for cleaning. Once the glass surfaces are scratched, it is impossible to restore the original finish. Special care must be taken to prevent damage when cleaning the glass. Anthony recommends specific products for routine cleaning of Standard glass.

1. **Cleaning Cloths**

Two cleaning cloth products are recommended. These cloths will normally remove dust, grease, oil, and fingerprints without the need for cleaning fluids.

a. **Scotch-Brite® High Performance Cloth**

This cloth is manufactured by 3M® and available in most grocery stores under the name Scotch-Brite® Microfiber Cleaning Cloth in a 12" x 14" size. This cloth is washable and may be reused as long as it remains clean.

b. **Spontex® Microfibre Cleaning Cloth**

This cloth is distributed by Spontex® and available in most grocery stores under the same name in a 15.75" x 12" size. This cloth is washable and maybe reused as long as it remains clean.

2. **Cleaning Fluid**

For more difficult cleaning jobs, several products are recommended. A light spray of these cleaning fluids will reduce the time required for cleaning. These materials have been tested and proven to not scratch or damage Standard glass.

- a. **Windex[®] Standard Product Only**
Extra-strength or specialty products may not be suitable and damage the glass.
- b. **Glass-Plus[®] Standard Product Only**
Extra-strength or specialty products may not be suitable and damage the glass.
- c. **Exceed[®] Multi-Surface and Glass Cleaner**
Source is Kay Chemical Company, Greensboro, NC.
- d. **Warm Water**

| NOTICE | |
|---|--|
|  | <i>Equivalent store-brand glass cleaning products are normally acceptable substitutes to the brand name products listed above.</i> |

3. **Materials NOT to Use**

Under NO circumstances should any of the following types of materials be used for cleaning Standard glass.

- a. Abrasives such as coarse paper towels, scouring pads or powders and steel wool or steel fiber materials.
- b. Blades
- c. Detergents that are acidic or highly alkaline or fluorine-based.

Preventative Inspection and maintenance

List of Items that require routine periodical inspection/maintenance:

- **Frame & Door** - Regularly check for wear/tear on frame and door which can include:
 - Ensuring that warning labels are all intact
 - Ensure all screws of back of door are secure and intact
 - Ensure all plastic backs are secure and undamaged
 - Handles are secure to door
 - Rails are intact, not broken and securely in place
 - Inspect Door Hinging area
 - Inspect Hinge pin assembly for wear/tear
- **Gaskets** – When inspecting gaskets ensure that they are sealing properly along top and sides of door frame. Also ensure that the gasket is properly secured to the door frame. Inspect and ensure gaskets are free of cracks, tears, deformities, and hardening.

Gasket Replacement Guidelines

Please read guidelines in their entirety. For personal and system safety, and for optimum product performance, make sure you thoroughly understand the contents before installing, using, or maintaining this product.

Preliminary Considerations for Servicing Gaskets

Tools Required

- Scraper to remove old Gasket Adhesive

Recommendations and Suggestions

- Keep doors and frames surfaces clean for product efficiency. This can also help reduce energy consumption and potential health hazards.
- Whenever binding gasket or plastic parts; use food grade silicone.
- Always use the correct tool for the job to be performed. This ensures proper installation and minimizes safety risks.
- If there is any doubt about the work to be performed, consult with a certified technician or Anthony representative.
- Preventative maintenance is recommended to ensure product longevity.

Section 7 - Trouble Shooting

Table 7.1: Installation Troubleshooting

| PROBLEM / ISSUE | PROBABLE CAUSES / FIXES | FINAL REMEDY |
|---|---|---|
| Condensation on Door Glass, Door Rail, or Frame | Fan to Door Proximity too small | Install air deflector |
| | Evaporator fans blowing cold air directly onto glass/frames | |
| | Shelves not fully stocked | Stock merchandise |
| | Door / gasket seal malfunction | See "Insulation or Air Leaks" |
| | Store conditions (temperature and relative humidity) outside required parameters | Adjust HVAC / Dehumidifier settings to meet required parameters |
| | Cooler temperature set too low | Adjust cooler temperature to design specified setting |
| Condensation in between Glass Panes | Seal compromised cause loss of gas or vacuum (check by cleaning glass on merchandise and customer sides) | Replace door |
| Ice buildup inside Freezer | Air infiltration Box / frame not sealed according to Anthony instructions | See "Insulation or Air Leaks" Ensure frame and box sealed according to Anthony Quick Installation |
| Door not closing or sealing | Check gasket to ensure proper installation | Replace gasket bubble seal |
| | Check gasket bubble seal for damage | |
| | Check Door closure | Replace Door closure |
| | Check Frame/Door is square | |
| | Check Plastic covers on rails | Replace Plastic Covers |
| No Power to Frame | Check Power Supply | Adjust energy controller to Full-On |
| | Check energy/humidity controller | Replace Power Supply |
| | Check hinge pin connections | Replace Energy/Humidity Controller |
| | Check humidity controller | Replace wiring |
| | Check the Amp draws to the heater wires in the frame | |
| Door/Gasket Seal - Malfunction | Check gasket Bubble seal | Replace gasket bubble seal |
| | Check door closure | Replace door closure |
| | Check Wiper on Bottom Doors and Wiper in between the doors (For Twin door) | Replace door Wiper |
| | Check Door is square and level | |
| Frame not Square or Plumb | Frame not properly shimmed | Use correct Shim to level frame |
| | Frame should be square to within 1/16" | Use rubber mallet to adjust frame plumb within 1/16" |
| | Frame should be plumb within 1/16" | |
| Insulation or Air Leaks | Frame must be properly shimmed, level, and plumb | Seal gaps with approved NSF approved Food Grade Silicone Sealant per Quick Installation Requirements Guide. |
| | Use RTV-108 NSF Approved Silicone Caulk to fill the perimeter of frame on refrigeration side (inside case) and at all frame joints as required so there are no air gaps. | |
| | Use RTV-108 NSF Approved Silicone Caulk to fill the perimeter of frame on refrigeration side (outside the case) and at all frame joints as required so there are no air gaps. | |
| | Ensure Gap between frame and refrigeration does not exceed 1/8", gaps larger than 1/8" will require additional shimming to reduce gap size before sealing | |
| | Ensure all electrical conduits are properly sealed to prevent moisture and air from migrating into the box, use RTV-108 NSF Approved Silicone Caulking if necessary | |

Section 8 - Frame Auto-Lock Replacement instructions

This section provides the information needed to safely perform replacement of the frame mounted Auto-Lock in the event it needs to be replaced. Both the Door and Frame must be removed to access the Auto-Lock for replacement. Use the following instructions to replace the Auto-Lock.

Door Removal

1. Unplug the SJ electrical cord located inside of the refrigerator side on the top back of the door frame, as shown below.



2. Remove the door closer arm by unscrewing the Phillips head screw from underneath and threaded pin to release the door closer arm from the door, as shown below.

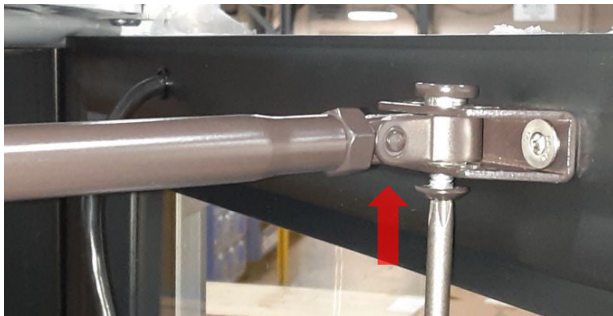

3. Remove the cap from the top hinge with a screwdriver. Insert and push down the spring-loaded pin from the top to disengage the door from the frame. As soon the top pin is pushed down the door will break free from the frame, as shown below.



Frame Removal

1. Remove two flat head screws from the bottom hinge plate bracket to expose the floor anchor. Afterwards, remove the floor countersunk anchor screw, as shown below.

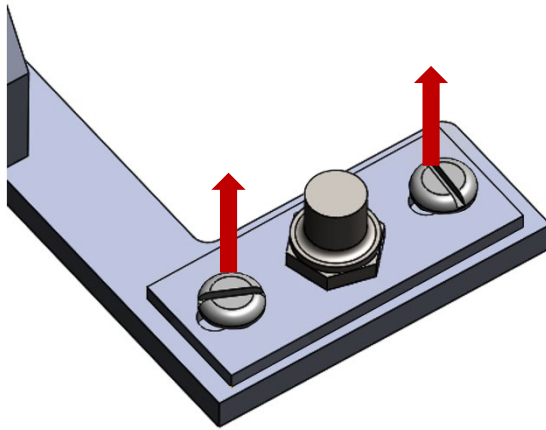

2. Remove all installation screws from frame perimeter remove frame from opening. Screws are located on top and left and right frame sides.

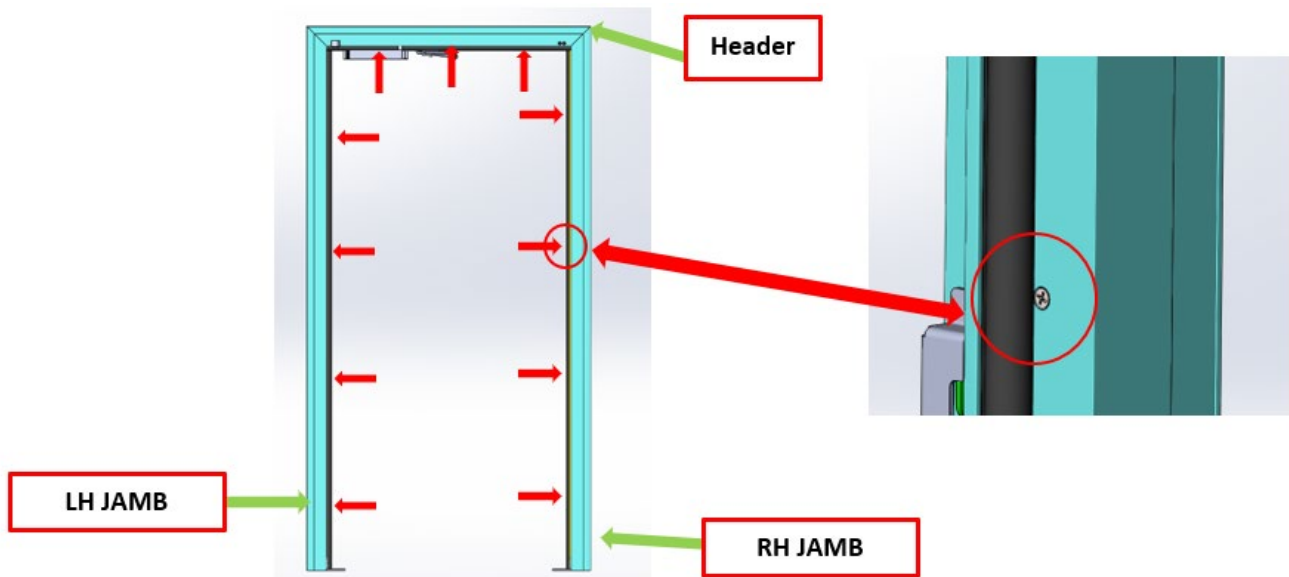

3. Once the frame has been removed locate the Jamb opposite from the hinge and remove the plastic from the back to access the auto-lock components.

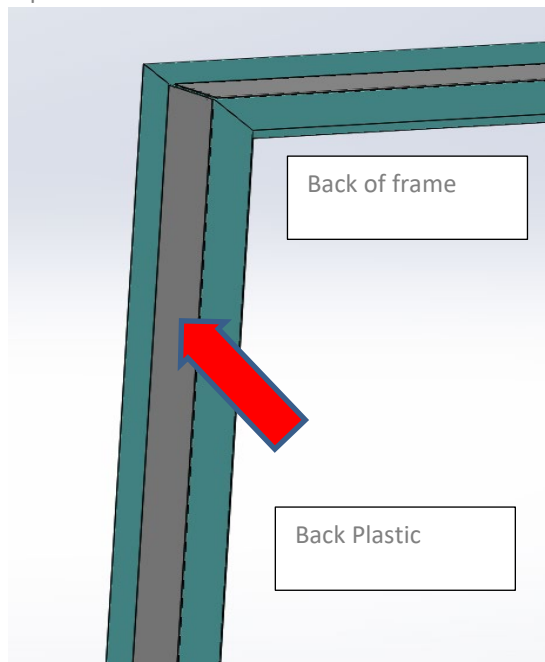

4. Once the back plastic has been removed there will be two auto-locks. Disconnect defective Auto-lock from connectors and unscrew 4 Phillips head screws from the front side of the frame.

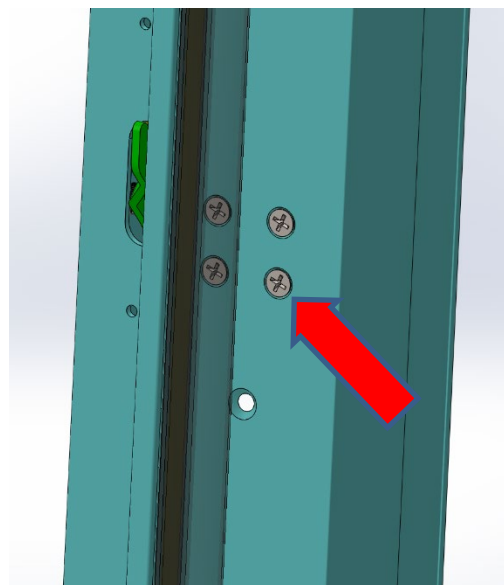
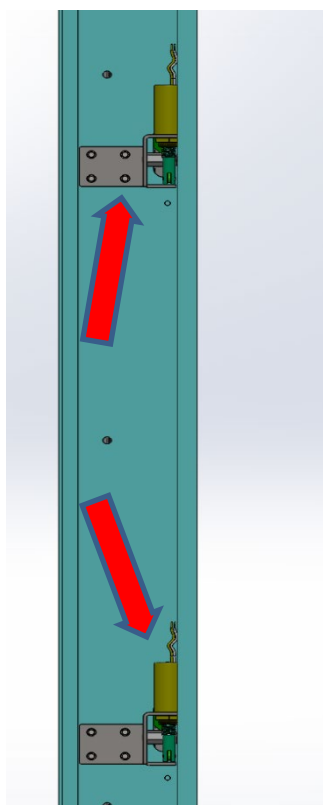

- When the defective Auto-lock has been removed from the frame install a new lock using the same hardware as the defective lock and connect wires in the same connectors. See next page for wiring diagram.

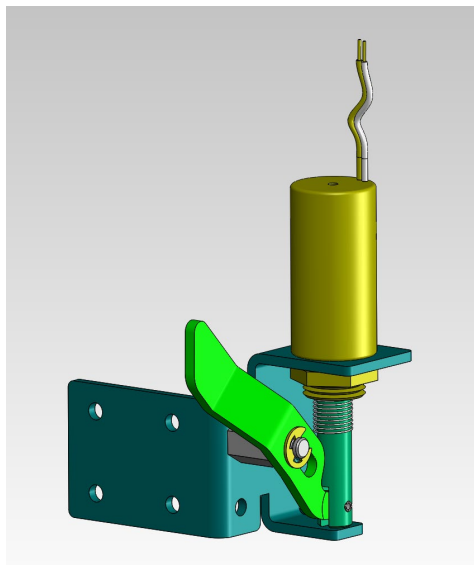

Anthony Auto-Lock part number 02-25511-0000

Note: If new hardware is needed refer to part number 04-25511-0000 This will include Auto Lock and Hardware.

- Re-install frame back plastic

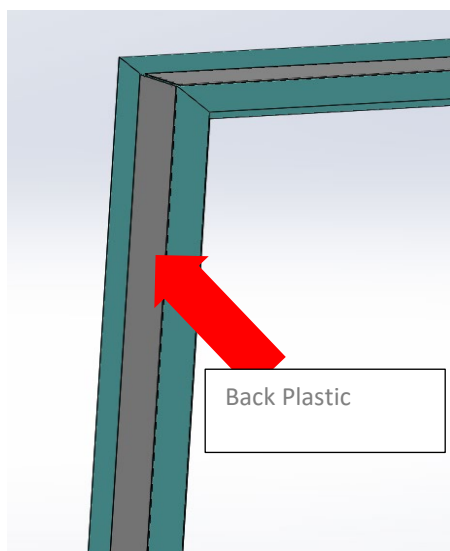

- When the installation is completed see Kodiak installation instructions in sections 4 and 5 for the reinstallation of the frame and door.

Electrical Auto-Lock wiring diagram Anthony # 07-24960-0000

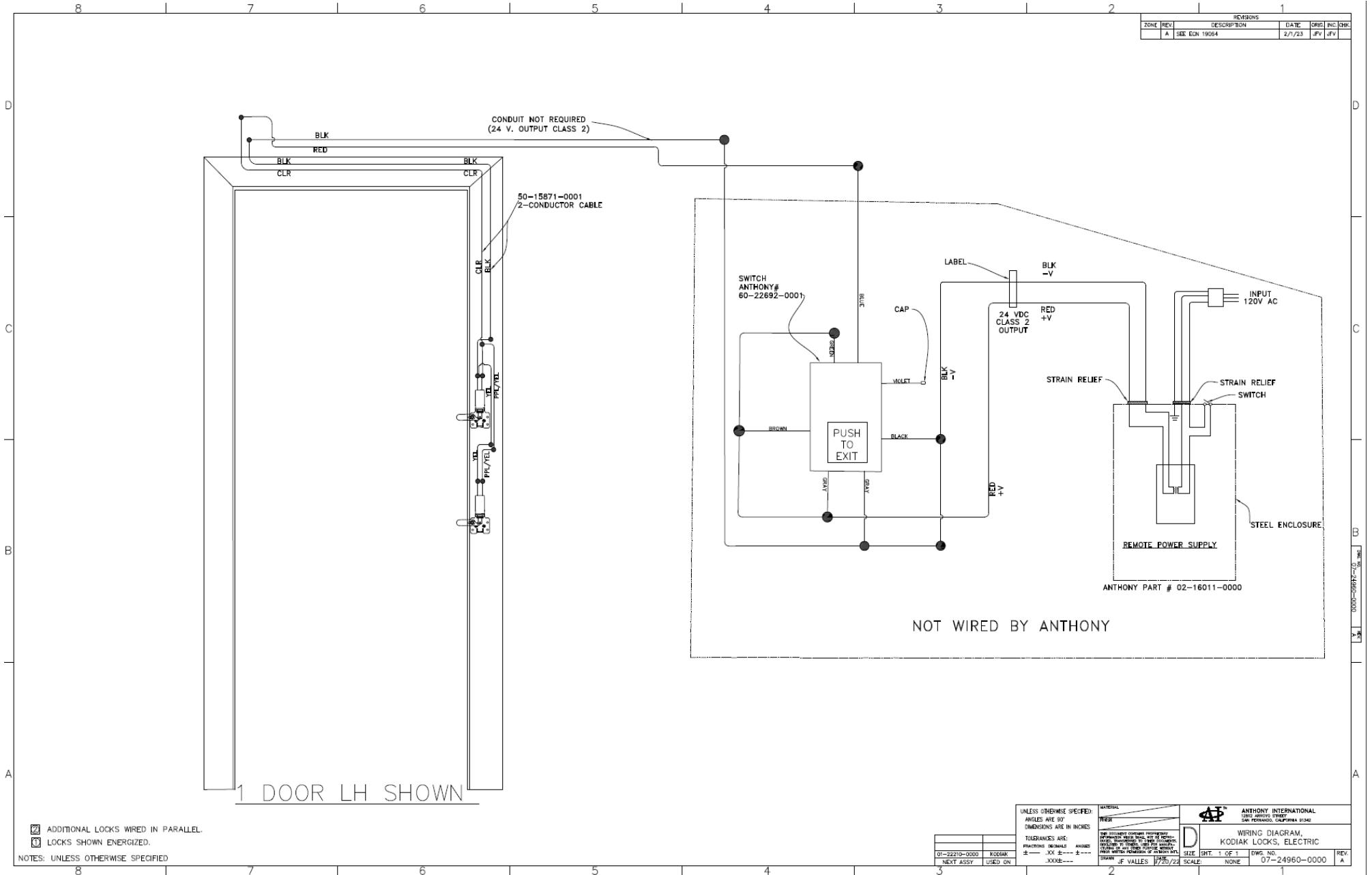

| ZONE | REV. | DESCRIPTION | DATE | CRD | INC | CHK |
|------|---------|-------------|--------|-----|-----|-----|
| A | SEE EDN | 19004 | 2/1/23 | JFV | JFV | |

- ADDITIONAL LOCKS WIRED IN PARALLEL.
 - LOCKS SHOWN ENERGIZED.
- NOTES: UNLESS OTHERWISE SPECIFIED

| | | | |
|---|--|---|--|
| UNLESS OTHERWISE SPECIFIED: ANGLES ARE 90° DIMENSIONS ARE IN INCHES TOLERANCES ARE: FRACTIONS (DECIMALS) ANGLES ± .XX ± .--- ± .--- XXX± .--- | | ANTHONY INTERNATIONAL 1333 AVENUE ONE SAN FERNANDO, CALIFORNIA 91340 | |
| 01-22370-0000 KODIAK NEXT ASSY USED ON | | WIRING DIAGRAM, KODIAK LOCKS, ELECTRIC SIZE: D SHT. 1 OF 1 DWG. NO. 07-24960-0000 SCALE: NONE J.F. VALLES 1/25/23 | |

Revision History

| REV | ORIGINATOR | DESCRIPTION OF CHANGE | DATE |
|-----|-------------------------|--|------------|
| A | Harvey Tsui | Initial Release | 07/05/2015 |
| B | A. Martinez/S. Srinivas | Reformatted and updated | 02/08/22 |
| C | A. Martinez | Updated images and Instructions for door alignment/adjustment See ECN 18496 | 06/30/2022 |
| D | A. Martinez / J.Valles | Updated images and Instructions for Auto-Lock Replacement See ECN 18822 | 09/28/2022 |
| E | J. Valles | Updated Auto-lock wiring diagram with Push To Exit Switch See ECN | 2/16/2023 |
| | | | |
| | | | |